











CLAMP MULTIMETER

*El modelo Chauvin Arnoux F203
es el equivalente al modelo AEMC 203*

F203



CONTENTS

1	PRESENTATION	7
1.1	THE SWITCH.....	8
1.2	THE KEYS OF THE KEYPAD.....	9
1.3	THE DISPLAY UNIT.....	10
1.3.1	<i>The symbols of the display unit</i>	11
1.3.2	<i>Measurement capacity exceeded (O.L.)</i>	12
1.4	THE TERMINALS.....	12
2	THE KEYS	12
2.1	 KEY.....	13
2.2	 KEY (SECOND FUNCTION).....	13
2.3	 KEY.....	14
2.4	 KEY.....	14
2.4.1	<i>In the normal mode</i>	14
2.4.2	<i>The MAX/MIN mode + activation of the HOLD mode</i>	15
2.4.3	<i>Access to the True-INRUSH mode ( set to )</i>	15
2.5	 KEY.....	16
2.5.1	<i>The Hz function in the normal model</i>	16
2.5.2	<i>The Hz function + activation of the HOLD mode</i>	16
2.6	 KEY.....	17
3	USE	18
3.1	COMMISSIONING.....	18
3.2	STARTING UP THE CLAMP MULTIMETER.....	18
3.3	SWITCHING THE CLAMP MULTIMETER.....	18
3.4	CONFIGURATION.....	19
3.4.1	<i>Programming of the maximum resistance allowed for a continuity</i>	19
3.4.2	<i>De-activation of automatic switching off (Auto Power OFF)</i>	19
3.4.3	<i>Programming of the current threshold for the True INRUSH measurement</i>	19
3.4.4	<i>Change of temperature measurement unit</i>	20
3.4.5	<i>Programming of the Adapter function scale factor</i>	21
3.4.6	<i>Default configuration</i>	21
3.5	VOLTAGE MEASUREMENT (V).....	21
3.6	CONTINUITY TEST 	22
3.6.1	<i>Automatic compensation of the resistance of the leads</i>	23
3.7	RESISTANCE MEASUREMENT Ω	23
3.8	DIODE TEST 	24

3.9	CURRENT MEASUREMENT (A).....	24
3.9.1	AC measurement.....	24
3.9.2	DC measurement.....	25
3.10	STARTING CURRENT OR OVERCURRENT (TRUE INRUSH) MEASUREMENT 26	
3.11	FREQUENCY MEASUREMENT (Hz)	26
3.11.1	Frequency measurement in voltage.....	27
3.11.2	Frequency measurement in current.....	27
3.12	TEMPERATURE MEASUREMENT	29
3.12.1	Measurement without external sensor.....	29
3.12.2	Measurement with external sensor.....	29
3.13	ADAPTER FUNCTION MEASUREMENT	30
4	CHARACTERISTICS.....	31
4.1	REFERENCE CONDITIONS	31
4.2	CHARACTERISTICS UNDER THE REFERENCE CONDITIONS.....	31
4.2.1	DC voltage measurement.....	32
4.2.2	AC voltage measurement	32
4.2.3	DC current measurement.....	33
4.2.4	AC current measurement	33
4.2.5	True-Inrush measurement.....	33
4.2.6	Continuity measurement	34
4.2.7	Resistance measurement	34
4.2.8	Diode test.....	34
4.2.9	Frequency measurements.....	35
4.2.10	Temperature measurement.....	35
4.2.11	Adapter function measurement	36
4.3	ENVIRONMENTAL CONDITIONS	37
4.4	CHARACTERISTICS OF CONSTRUCTION	37
4.5	POWER SUPPLY	38
4.6	COMPLIANCE WITH INTERNATIONAL STANDARDS	38
4.7	VARIATIONS IN THE DOMAIN OF USE	38
5	MAINTENANCE.....	39
5.1	CLEANING.....	39
5.2	REPLACEMENT OF THE BATTERY	40
5.3	METROLOGICAL CHECK.....	40
5.4	REPAIR	40
6	WARRANTY	40
7	DELIVERY CONDITION.....	41

You have just acquired an **F203 clamp multimeter** and we thank you.

For best results from your device :

- **read** this user manual attentively,
- **observe** the precautions for its use.

Meanings of the symbols used on the device



Danger. The operator agrees to refer to this data sheet whenever this danger symbol is encountered.



Application or withdrawal authorized on uninsulated or bare conductors at dangerous voltages.



9 V battery.



The CE marking indicates compliance with European directives.



Double insulation or reinforced insulation.



Selective sorting of wastes for the recycling of electrical and electronic equipment within the European Union.



In conformity with directive DEEE 2002/96/EC: this equipment must not be treated as household waste.



AC – Alternating current.



AC and DC – Alternating and direct current.



Earth.



Risk of electric shock.

PRECAUTIONS FOR USE

This device complies with safety standards IEC-61010-1 and 61010-2-032 for voltages of 1,000V in category III or 600V in category IV at an altitude OF less than 2000m, indoors, with a degree of pollution not exceeding 2.

These safety instructions are intended to ensure the safety of persons and proper operation of the device. If the tester is used other than as specified in this data sheet, the protection provided by the device may be impaired.

- The operator and/or the responsible authority must carefully read and clearly understand the various precautions to be taken in use.
- If you use this instrument other than as specified, the protection it provides may be compromised, thereby endangering you.
- Do not use the instrument in an explosive atmosphere or in the presence of flammable gases or fumes.
- Do not use the instrument on networks of which the voltage or category exceeds those mentioned.
- Do not exceed the rated maximum voltages and currents between terminals or with respect to earth.
- Do not use the instrument if it appears to be damaged, incomplete, or not properly closed.
- Before each use, check the condition of the insulation on the leads, housing, and accessories. Any element of which the insulation is deteriorated (even partially) must be set aside for repair or scrapped.
- Use leads and accessories rated for voltages and categories at least equal to those of the instrument. If not, an accessory of a lower category lowers the category of the combined Clamp + accessory to that of the accessory.
- Observe the environmental conditions of use.
- Do not modify the instrument and do not replace components with "equivalents". Repairs and adjustments must be done by approved qualified personnel.
- Replace the battery as soon as the  symbol appears on the display unit. Disconnect all cords before opening the battery compartment cover.
- Use personal protective equipment when conditions require.
- Keep your hands away from the unused terminals of the instrument.
- When handling the test probes, crocodile clips, and clamp ammeters, keep your fingers behind the physical guard.

- As a safety measure, and to avoid repeated overloads on the inputs of the device, we recommend performing configuration operations only when the device is disconnected from all dangerous voltages.

MEASUREMENT CATEGORIES

Definitions of the measurement categories :

CAT II: Circuits directly connected to the low-voltage installation.

Example: power supply to household electrical appliances and portable tools.

CAT III: Power supply circuits in the installation of the building.

Example: distribution panel, circuit-breakers, fixed industrial machines or devices.

CAT IV: Circuits supplying the low-voltage installation of the building.

Example: power lines, meters, and protection devices.

1 PRESENTATION

The **F203** is a professional electrical measuring instrument that combines the following functions:

- Current measurement;
- Measurement of inrush current / overcurrent (True-Inrush);
- Voltage measurement;
- Frequency measurement;
- Continuity test with buzzer;
- Resistance measurement;
- Diode test;
- Temperature measurement;
- Adapter function



Item	Designation	See §
1	Jaws with centring marks (see connection principles)	3.5 to 3.12
2	Physical guard	-
3	Switch	1.1
4	Function keys	2
5	Display unit	1.3
6	Terminals	1.4
7	Trigger	-

Figure 1 : the F203 clamp multimeter

1.1 THE SWITCH

The switch has six positions. To access the **V_~**, **V_⎓**, **A_~**, **A_⎓**, **Ω**, **Diode**, **Adp_~**, functions, set the switch to the desired function. Each setting is confirmed by an audible signal. The functions are described in the table below.

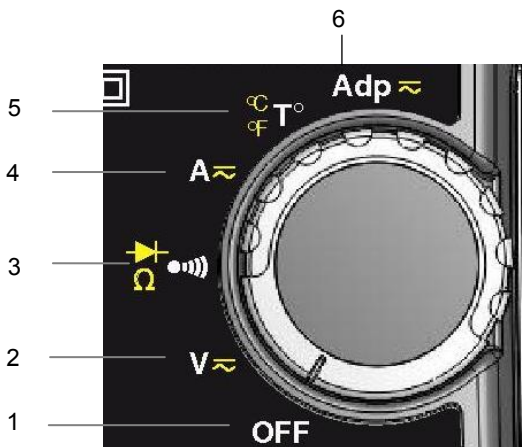



Figure 2 : the switch

Item	Function	See §
1	OFF mode – Switches the clamp multimeter off	3.3
2	AC, DC voltage measurement (V)	3.5
3	Continuity test 	3.6
	Resistance measurement Ω	3.7
	Diode test 	3.8
4	AC, DC current measurement (A)	3.9
5	Temperature measurement (°C/°F)	3.12
6	Adapter function	3.13

1.2 THE KEYS OF THE KEYPAD

Here are the six keys of the keypad :

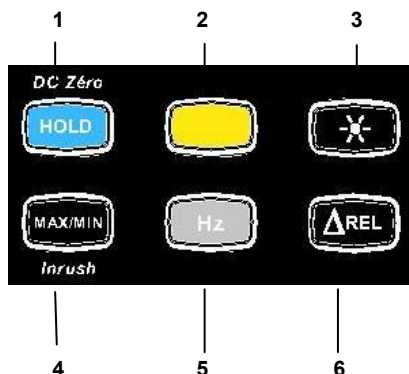

Figure 3 : the keys of the keypad

Item	Function	See §
1	Storage of values, disabling of display Zero correction A_{DC} Compensation of the resistance of the leads in the continuity and ohmmeter function	2.1 3.9.2 3.6.1
2	Selection of the type of measurement (AC, DC)	2.2
3	Activation or de-activation of the backlighting of the display unit	2.3
4	Activation or de-activation of the MAX/MIN mode Activation or de-activation of the INRUSH mode in A	2.4
5	Frequency measurements (Hz)	2.5
6	Activation of Δ REL mode – Display of differential and relative values	2.6

1.3 THE DISPLAY UNIT

Here is the display unit of the clamp multimeter:

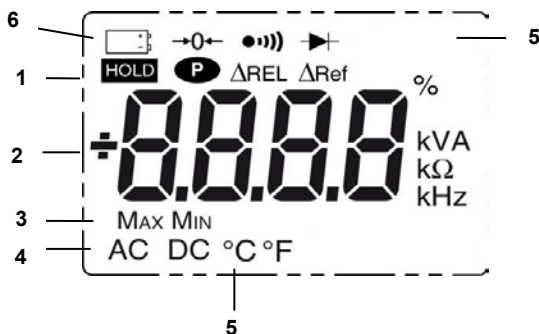





Figure 4 : the display unit

Item	Function	See §
1	Display of the modes selected (keys)	2
2	Display of the measurement value and unit	3.5 to 3.12
3	Display of the MAX/MIN modes	2.4
4	Type of measurement (AC or DC)	2.2
5	Display of the selected modes (switch)	1.1
6	Spent battery indication	5.2

1.3.1 The symbols of the display unit

Symbol	Designation
AC	Alternating current or voltage
DC	Direct current or voltage
Δ REL	Relative value, with respect to a reference
Δ Ref	Reference value
HOLD	Storage of the values and hold of the display
Max	Maximum RMS value
Min	Minimum RMS value
V	Volt
Hz	Hertz
A	Ampere
%	Percentage
Ω	Ohm
m	Milli- prefix
k	Kilo- prefix
$\rightarrow 0 \leftarrow$	Compensation of the resistance of the leads
	Continuity test
	Diode test
	Permanent display (automatic switching off de-activated)
	Spent battery indicator

1.3.2 Measurement capacity exceeded (O.L)

The **O.L** (Over Load) symbol is displayed when the display capacity is exceeded.

1.4 THE TERMINALS

The terminals are used as follows:

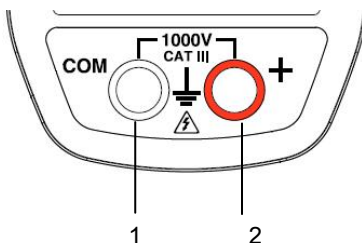

Figure 5 : the terminals

Item	Function
1	Cold terminal (COM)
2	Hot terminal (+)

2 THE KEYS

The keys of the keypad respond differently to short, long, and sustained presses.

The **MAX/MIN**, **Hz**, and **REL** keys provide new functions and allow the detection and acquisition of parameters complementary to the usual elementary measurements.

Each of these keys can be used independently of the others or in perfect complementarity with them: this makes navigation simple and intuitive for looking up all measurement results.









It is possible, for example, to look up in turn the MAX, MIN, etc. values of the RMS voltage only, then display relative values in parallel.

In this section, the  icon represents the possible positions of the switch for which the key concerned has some action.

2.1 KEY

This key is used to:

- store and look up the last values acquired specific to each function (V, A, Ω , T°, Adp) according to the specific modes previously activated (MAX/MIN, Hz, Δ REL); the present display is then maintained while the detection and acquisition of new values continues;
- perform automatic compensation of the resistance of the leads (see also § [3.6.1](#));
- perform automatic zero correction in A DC (see also § [3.9.2](#));

Successive presses on 		... serve
Short	    	<ol style="list-style-type: none"> 1. to store the results of the present measurements 2. to hold the display of the last value displayed 3. to return to normal display mode (the value of each new measurement is displayed)
Long (> 2 sec)	ADC	Perform an automatic zero correction (see 3.9.2) Remark : this mode operates if the MAX/MIN or HOLD modes (short press) are first de activated.
Sustained		to perform automatic compensation of the resistance of the leads (see 3.6.1)









See also § [2.4.2](#) and § [2.5.2](#) for the action  key with the action of the  key and with the action of the  key.

2.2 KEY (SECOND FUNCTION)

This key is used to select the type of measurement (AC, DC) and the second functions marked in yellow next to the relevant positions of the switch.









It can also be used, in the configuration mode, to modify the default values (see § [3.4](#))

Remark: the key is invalid in the MAX/MIN, HOLD and Δ REL modes.

Successive presses on 		... serve
	  	-to select AC or DC. Depending on your choice, the screen displays AC or DC
		-to cycle through the Ω and diode test \rightarrow modes and to return to the continuity test \bullet)
	 	-to select °C or °F as the unit

2.3 KEY

This key is used to backlight the display unit.

Successive presses on 		... serve
	     	-to activate or de-activate the backlighting of the screen











Remark: the backlighting is switched off automatically at the end of 2 minutes.

2.4 KEY

2.4.1 In the normal mode









This key activates detection of the MAX and MIN values of the measurements made. Max and Min are the extreme mean values in DC and the extreme RMS values in AC.

Remark : in this mode, the "automatic switching off" function of the device is automatically de-activated. The  symbol is displayed on the screen.

Successive presses on 		... serve
short	   	-to activate detection of the MAX/MIN values -to display the MAX or MIN value successively -to return to display of the present measurement without exiting from the mode (the values already detected are not erased) <i>Remark:</i> the MAX and MIN symbols are both displayed, but only the symbol of the quantity selected blinks. Example: If MIN has been selected, MIN blinks and MAX is lit steadily.
long (> 2 sec)	    	to exit from the MAX/MIN mode. The values previously recorded are then erased. <i>Remark:</i> if the HOLD function is activated, it is not possible to exit from the MAX/MIN mode. The HOLD function must first be de-activated.

Remark : ΔREL function can be used with the functions of the MAX/MIN mode.



2.4.2 The MAX/MIN mode + activation of the HOLD mode



Successive presses on 		... serve
short	    	to display successively the MAX/MIN values detected before the  key was pressed

Note: the HOLD function does not interrupt the acquisition of new MAX, MIN values

2.4.3 Access to the True-INRUSH mode (set to)

This key allows measurement of the True-Inrush current (starting current, or overcurrent in steady-state operation) for AC or DC current.

Successive presses on 		...serves





<p>long (>2 sec)</p>		<p>to enter the True-INRUSH mode</p> <ul style="list-style-type: none"> - "Inrh" is displayed for 3s (the backlighting blinks) - the triggering threshold is displayed for 5s (the backlighting is steady); - "-----" is displayed and the "A" symbol flashes - after detection and acquisition, the inrush current measurement is displayed, after the calculations stage "-----" (backlighting off) <p><i>Remark:</i> the A symbol flashes to indicate "surveillance" of the signal.</p> <p>to exit from the True-INRUSH mode (return to simple current measurement).</p>
<p>short (<2 sec)</p> <p>Note: a short press is functional only if an True-Inrush value has been detected.</p>		<ul style="list-style-type: none"> - to display the PEAK+ value of the current - to display the PEAK- value of the current - to display the RMS True-Inrush current <p><i>Remark:</i> the A symbol is displayed steadily during this sequence.</p>

2.5 KEY

This key is used to display the frequency measurements of a signal.



Remark : this button is not functional in DC mode.

2.5.1 The Hz function in the normal model

<p>Successive presses on </p>		<p>...serves</p>
	 	<p>to display:</p> <ul style="list-style-type: none"> - the frequency of the signal measured - the present voltage (V) or current (A) measurement













2.5.2 The Hz function + activation of the HOLD mode

<p>Successive presses on </p>		<p>...serves</p>
--	---	------------------

		-to store the frequency
		-to display successively the stored frequency, then the voltage or the current

2.6 KEY

This key is used to display and store the reference value in the unit of magnitude measured, or to display the differential and relative values, in %.

Successive presses on 		...serve
		- to enter the ΔREL mode, to store then display the reference value. The ΔRef symbol is displayed.
short		
		- to display the differential value: - (current value – reference (Δ)) The ΔREL symbol is displayed.
		- to display the relative value in % current value – reference (Δ) reference (Δ) The ΔREL and % symbols are displayed.
		- to display the reference. The ΔRef symbol is displayed - to display the current value. The ΔRef symbol blinks.
long (>2 sec)	    	to exit from the ΔREL mode

Remark : the “Relative mode ΔREL” function can be used with the functions of the MAX/MIN mode.

3 USE

3.1 COMMISSIONING

Insert the battery supplied with the device as follows:

1. Using a screwdriver, unscrew the screw of the battery compartment cover (item 1) on the back of the housing and open it.
2. Place the battery in the compartment (item 2), taking care to get the polarities right.
3. Close the battery compartment cover and screw it to the housing.

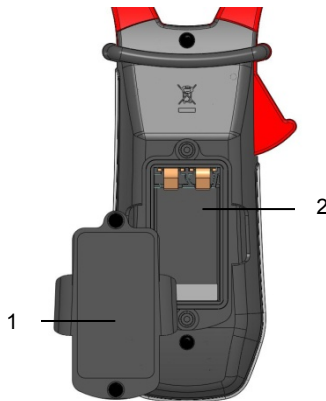

Figure 6 : the battery compartment cover

3.2 STARTING UP THE CLAMP MULTIMETER

The switch is set to OFF. Turn the switch to the function of your choice. The whole display lights (all symbols) for a few seconds (see §1.3), then the screen of the function chosen is displayed. The clamp multimeter is then ready to make measurements.

3.3 SWITCHING THE CLAMP MULTIMETER







The clamp multimeter can be switched off either manually, by setting the switch to OFF, or automatically, after ten minutes with no action on the switch and/or the keys. Thirty (30) seconds before the device is switched off, an audible signal sounds intermittently. To re-activate the device, press any key or turn the switch.

3.4 CONFIGURATION

As a safety measure, and to avoid repeated overloads on the inputs of the device, we recommend performing configuration operations only when the device is disconnected from all dangerous voltages.

3.4.1 Programming of the maximum resistance allowed for a continuity



To program the maximum resistance allowed for a continuity

1. From the OFF position, hold the  key down while turning the switch to , until the "full screen" display ends and a beep is emitted, to enter the configuration mode. The display unit indicates the value below which the buzzer is activated and the  symbol is displayed. The value stored by default is 40Ω. The possible values lie between 1Ω and 599Ω.
2. To change the threshold, press the  key. The right-hand digit flashes: each press on the  key increments it. To shift to the next digit, apply a long press (>2s) to the  key.

To exit from the programming mode, turn the switch to another setting. The detection threshold chosen is stored (emission of a double beep).

3.4.2 De-activation of automatic switching off (Auto Power OFF)

To de-activate automatic switching off:



In the OFF position, hold the  key down while turning the switch to , until the "full screen" display ends and a beep is emitted, to enter the configuration mode. The  symbol is displayed.

When the  key is released, the device is in the voltmeter function in the normal mode.

The return to Auto Power OFF takes place when the clamp is switched back on.



3.4.3 Programming of the current threshold for the True INRUSH measurement

To program the triggering current threshold of the True INRUSH measurement:

1. in the OFF position, hold the  key down while turning the switch to , until the "full screen" display ends and a beep is emitted, to enter the configuration mode. The display unit indicates the percentage overshoot to

apply to the measured current to determine the measurement triggering threshold.

The value stored by default is 10%, representing 110% of the established current measured. The possible values are 5%, 10%, 20%, 50%, 70%, 100%, 150%, and 200%.



2. To change the threshold, press the  key. The value flashes: each press on the  key displays the next value. To record the chosen threshold, apply a long press (>2s) on the  key. A confirmation beep is emitted.

To exit from the programming mode, turn the switch to another setting. The chosen threshold is stored (emission of a double beep).

Note: The starting (Inrush) current measurement triggering threshold is fixed at 1% of the least sensitive range. This threshold is not adjustable .

3.4.4 Change of temperature measurement unit





To program the measurement unit, °C or °F:

1. In the OFF position, hold the  key down while turning the switch to , until the "full screen" display ends and a beep is emitted, to enter the configuration mode. The display unit indicates the existing unit (°C or °F). The default unit is °C.
2. Pressing the  key toggles between °C and °F.

When the desired unit is displayed, turn the switch to another setting. The unit chosen is stored (emission of a double beep).

3.4.5 Programming of the Adapter function scale factor



To program the Adapter function scale factor :

1. From the OFF position, hold the  key down while turning the switch to  until the "full screen" display ends and a beep is emitted, to enter configuration mode. The display unit indicates the stored scale factor value.
The default stored value is 1. The possible values are, in order: 1, 10k, 100k, 100m, 10m, 1m, 100, 10. (see §3.13)
2. To change the value of the scale factor, press the  key. The currently active scale factor is displayed. Each press of the  key displays the next value in the list above.

Once the scale factor displayed has been chosen, turn the switch to another position. The value chosen is stored (a double beep is emitted).

3.4.6 Default configuration

To reset the clamp to its default parameters (factory configuration):

In the OFF position, hold the  key down while turning the switch to  until the "full screen" display ends and a beep is emitted, to enter the configuration mode. The "rSt" symbol is displayed.

After 2 s, the clamp emits a double beep, then all of the digital symbols of the screen are displayed until the  key is released. The default parameters are then restored:

Continuity detection threshold =40Ω
True Inrush triggering threshold =10%
Temperature measurement unit =°C
Adapter function scale factor = 1

3.5 VOLTAGE MEASUREMENT (V)

To measure a voltage, proceed as follows :

1. Set the switch to  ;
2. Connect the black lead to the **COM** terminal and the red lead to "+".
3. Place the test probes or the crocodile clips on the terminals of the circuit to be measured. The device selects AC or DC automatically according to which measured value is larger. The AC or DC symbol lights in blinking mode.

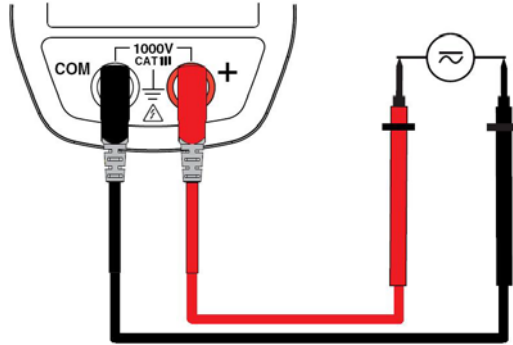

To select AC or DC manually, press the yellow key to reach the desired choice. The symbol corresponding to the choice made then lights in fixed mode.



The measured value is displayed on the screen.

3.6 CONTINUITY TEST

Warning : Before performing the test, make sure that the circuit is off and any capacitors have been discharged.

1. Set the switch to  ; the  symbol is displayed ;
2. Connect the black lead to the COM terminal and the red lead to «+».
3. Place the test probes or the crocodile clips on the terminals of the circuit or component to be tested.

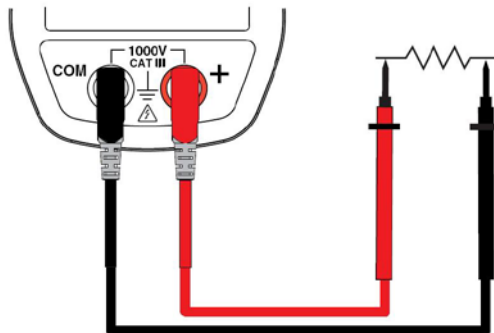

An audible signal is emitted if there is continuity, and the measured value is displayed on the screen.

3.6.1 Automatic compensation of the resistance of the leads

Warning : before the compensation is executed, the MAX/MIN and HOLD modes must be de-activated.

To perform automatic compensation of the resistance of the leads, proceed as follows:

1. Short-circuit the leads connected to the device.
2. Hold the **HOLD** key down until the display unit indicates the lowest value. The device measures the resistance of the leads.
3. Release the **HOLD** key. The correction and the $\rightarrow 0 \leftarrow$ symbole are displayed. The value displayed is stored.

Remark : the correction value is stored only if it is $\leq 2 \Omega$. Above 2Ω , the value displayed blinks and is not stored.

3.7 RESISTANCE MEASUREMENT Ω

Warning : Before making a resistance measurement, make sure that the circuit is cold and any capacitors have been discharged.

1. Set the switch to Ω and press the **Ω** key. The Ω symbol is displayed;
2. Connect the black lead to the **COM** terminal and the red lead to « + »;
3. Place the test probes or the crocodile clips on the terminals of the circuit or component to be measured ;

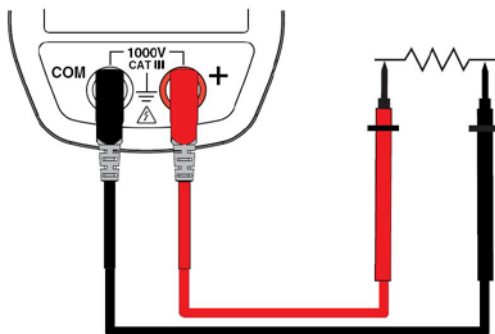

The measured value is displayed on the screen

Remark : to measure low resistance values, first carry out the compensation of the resistance of the leads (see § [3.6.1](#)).

3.8 DIODE TEST $\rightarrow|$

Warning: Before performing the diode test, make sure that the circuit is cold and any capacitors have been discharged.

1. Set the switch to $\rightarrow|$ and press the \square key twice. The $\rightarrow|$ symbol is displayed.
2. Connect the black lead to the COM terminal and the red lead to «+».
3. Place the test probes or the crocodile clips on the terminals of the component to be tested.

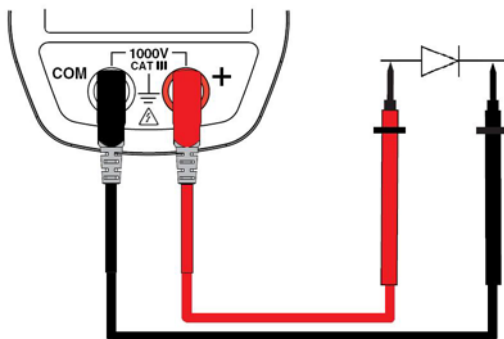

The measured value is displayed on the screen.

3.9 CURRENT MEASUREMENT (A)

The jaws are opened by pressing the trigger on the body of the device. The arrow on the jaws of the clamp (see the diagram below) must point in the presumed direction of flow of the current, from the generator to the load. Make sure that the jaws have closed correctly.

Remark: the measurement results are optimal when the conductor is centred in the jaws (aligned with the centring marks).

The device selects AC or DC automatically according to which measured value is larger. The AC or DC symbol lights in blinking mode.

3.9.1 AC measurement

For an AC current measurement, proceed as follows:

1. Set the switch to A and select AC by pressing the \square key. The AC symbol is displayed.

2. Encircle only the conductor concerned with the clamp. The device selects AC or DC automatically;

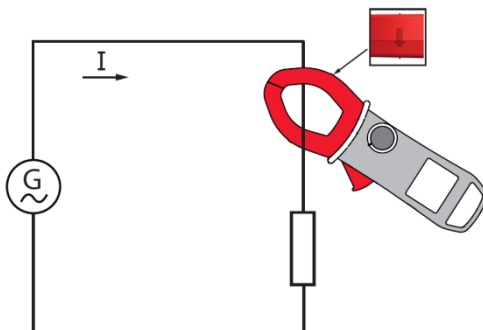

The measured value is displayed on the screen.

3.9.2 DC measurement

To measure the DC current, if the display unit does not indicate "0", first correct the DC zero as follows:

Step 1 : to correct the DC zero

Important : The clamp must not be closed on the conductor during the DC zero correction. Hold the clamp in the same position during the whole procedure so that the correction value will be exact.

Press the **HOLD** key until the device emits a double beep and displays a value near "0". The correction value is stored until the clamp is powered down.

Remark : the correction is effected only if the value displayed is $< \pm 6$ A, otherwise the value displayed blinks and is not stored. The clamp must be recalibrated (see §5.3)

Step 2 : to make a measurement

1. The switch is set to **A \approx** . Select DC by pressing the yellow key until the desired choice is reached.
2. Apply the clamp to only the conductor concerned.

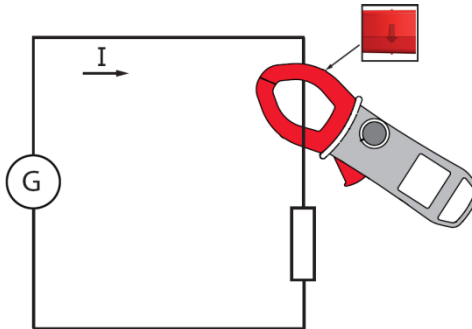

The measurement is displayed on screen.

3.10 STARTING CURRENT OR OVERCURRENT (TRUE INRUSH) MEASUREMENT

Remark : the measurement can be made only in AC or DC mode.

To measure a starting current or overcurrent, proceed as follows:

1. Set the switch to **A**, correct the DC zero (§ 3.9.2), then apply the clamp around the single conductor concerned.
2. Effect a long press on the **MAX/MIN** key. The InRh symbol is displayed, then the triggering threshold. The clamp then awaits detection of the True-Inrush current.
"-----" is displayed and the "A" symbol flashes.
3. After detection and acquisition for 100 ms, the RMS value of the True-Inrush current is displayed, along with the PEAK+/PEAK- values subsequently.
4. A long press on the **MAX/MIN** key or a change of function leads to exiting from the True-Inrush mode.

Remark : the triggering threshold in A is 6A if the initial current is zero (starting of installation); it is that set in the configuration (see §3.4.3) for an established current (overload in a installation).

3.11 FREQUENCY MEASUREMENT (HZ)

The frequency measurement is available in V and A for AC quantities. The measurement is based on a count of the passages of the signal through zero (positive-going edges).

3.11.1 Frequency measurement in voltage

To measure the frequency in voltage, proceed as follows:

1. Set the switch to **V_~** and press the **Hz** key. The Hz symbol is displayed.
2. Select AC by pressing the yellow key until the desired choice is reached.
3. Connect the black lead to the **COM** terminal and the red lead to “+”.
4. Place the test probes or the crocodile clips on the terminals of the circuit to be measured.

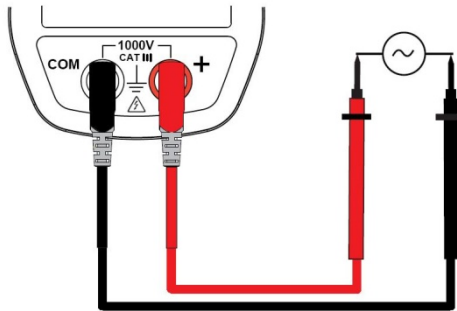

The measured value is displayed on the screen.

3.11.2 Frequency measurement in current

1. Set the switch to **A_~** and press the **Hz** key. The **Hz** symbol is displayed.
2. Select AC by pressing the yellow key until desired choice is reached.
3. Encircle only the conductor concerned with the clamp.

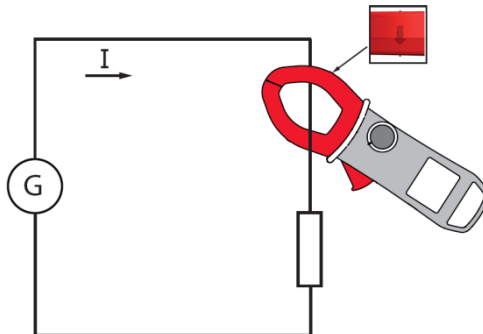

The measured value is displayed on the screen.

3.12 TEMPERATURE MEASUREMENT

3.12.1 Measurement without external sensor

1. Set the switch to .

The temperature displayed (blinking) is the internal temperature of the device, equal to the ambient temperature after a sufficiently long thermal stabilization time (at least one hour).

3.12.2 Measurement with external sensor

The device measures the temperature using a K thermocouple.

1. Connect the K thermocouple to the **+** and **COM** input terminals of the device.
2. Set the switch to .
3. Place the K thermocouple on the element or zone to be measured, which must not be at a dangerous voltage.

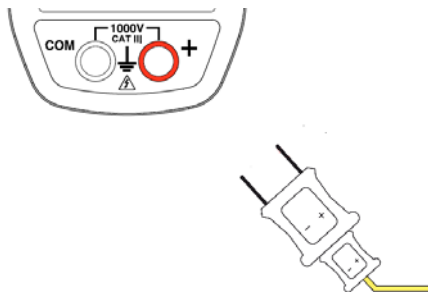

The temperature is displayed on the screen.

To change the unit, °F or °C, press the  key.

Remarks :

- If the external sensor is defective, the temperature displayed blinks.
- If there are large variations of the environment of the device, the measurement must be preceded by a stabilization time.

3.13 ADAPTER FUNCTION MEASUREMENT

This function makes it possible to connect any adapter/sensor whatever that converts an electrical or physical quantity into a DC or AC voltage, and obtain a direct, immediate reading without applying a conversion factor.

The mode, AC or DC (the default), must be chosen manually using the yellow key. The measurement is made as a voltage measurement.

The scale factor of the adapter must be chosen in advance in set-up (§3.4.5). The table below indicates the various adapter/sensor sensitivities that allow a direct reading once the scale factor has been chosen:

Sensitivity (S in mV/A) (example in Amperes)	Scale factor to be programmed
10 mV/kA (0,01 mV/A)	10 k
100 mV/kA (0,1 mV/A)	100 k
1 mV/A	1
10 mV/A	10
100 mV/A	100
1000 mV/A (1 mV/mA)	1 m
10 mV/mA	10 m
100 mV/mA	100 m

The example given in Amperes (A) is valid for any other quantity: humidity (%RH), illumination (lux), speed (m/s), etc.

1. Connect the black lead to the **COM** terminal and the red lead to « + » ;
2. Set the switch to **Adp** ; Select the AC or DC mode ;
3. Connect the adapter according to its directions for use ;

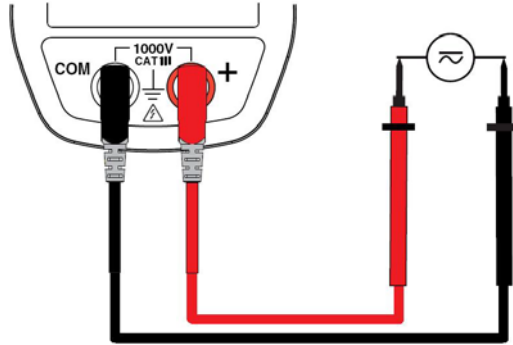

The value of the measurement is displayed on screen.

4 CHARACTERISTICS

4.1 REFERENCE CONDITIONS

Quantities of influence	Reference conditions
Temperature:	23°C ±2°C
Relative humidity:	45% to 75%
Supply voltage:	9.0V ±0.5V
Frequency range of the applied signal:	45–65Hz
Sine wave:	pure
Peak factor of the applied alternating signal:	$\sqrt{2}$
Position of the conductor in the clamp:	centred
Adjacent conductors:	none
Alternating magnetic field:	none
Electric field:	none

4.2 CHARACTERISTICS UNDER THE REFERENCE CONDITIONS

The uncertainties are expressed in ± (x% of the reading (R) + y points (pt)).

4.2.1 DC voltage measurement

Measurement range	0.00V to 59.99V	60.0V to 599.9V	600V to 1000V (1)
Specified measurement range	0 to 100% of the measurement range	0 to 100% of the measurement range	
Uncertainties	from 0.00V to 5.99V $\pm(1\% R + 10 \text{ pt})$ from 6.00V to 59.99V $\pm(1\% R + 3 \text{ pt})$	$\pm(1\% R + 3 \text{ pt})$	
Resolution	0.01V	0.1V	1V
Input impedance	10M Ω		

Note (1) The display indicates "+OL" above + 2 000 V and "-OL" below - 2 000 V, in REL mode. The "-" and "+" signs are managed. Above 1000V, a repetitive beep indicates that the voltage being measured is greater than the safety voltage for which the device is guaranteed.

4.2.2 AC voltage measurement

Measurement range	0.15V to 59.99V	60.0V to 599.9V	600V to 1000V RMS 1400V peak (1)
Specified measurement range (2)	0 to 100% of the measurement range		
Uncertainties	from 0.15V to 5.99V $\pm(1\% R + 10 \text{ pt})$ from 6.00V to 59.99V $\pm(1\% R + 3 \text{ pt})$	$\pm(1\% R + 3 \text{ pt})$	
Resolution	0.01V	0.1V	1V
Input impedance	10M Ω		

Note (1) Above 1,000V (RMS), a repetitive beep indicates that the voltage being measured is greater than the safety voltage for which the device is guaranteed.
Bandwidth in AC = 3 kHz

Note (2) Any value between zero and the min. threshold of the measurement range (0.15V) is forced to "----" on the display.

Specific characteristics in MAX/MIN mode (from 10Hz to 1kHz in AC, and from 0.30V) :

- Uncertainties: add 1% L to the values of the table above.

- Capture time of the extrema: approximately 100ms.

4.2.3 DC current measurement

Measurement Range (2)	0.00 A to 59.99 A	60.0 A to 599.9 A	600 A to 900 A (1)
Specified measurement range	0 to 100% of the measurement range		
Uncertainties (2) (zero corrected)	± (1% L + 10 pt)	± (1% L +3 pt)	
Resolution	0.01 A	0.1 A	1 A

Note (1) - The display indicates "+OL" above 1800 A and "-OL" below -1800 A in REL mode. The "-" and "+" signs are managed.

Note (2) - The residual current at zero depends on the remanence. It can be corrected by the "DC zero" function of the HOLD key.

4.2.4 AC current measurement

Measurement range	0.15A to 59.99A	60.0 A to 599.9 A	600 A (1)
Specified measurement range (2)	0 to 100% of the measurement range		
Uncertainties	± (1% R + 10 pt)	± (1% R +3 pt)	
Resolution	0.01A	0.1A	1A

Note (1) Bandwidth in AC = 3 kHz

Note (2) In AC, any value between zero and the min. threshold of the measurement range (0.15A) is forced to "----" on the display.

Specific characteristics in MAX/MIN mode (from 10Hz to 1kHz in AC, and from 0.30A):

- Uncertainties (with zero corrected): add 1% L to the values of the table above.
- Capture time of the extrema: approximately 100ms.

4.2.5 True-Inrush measurement

Measurement range	6 A to 600 A AC	6 A to 900 A DC
-------------------	-----------------	-----------------

Specified measurement range	0 to 100% of the measurement range
Uncertainties	$\pm (5\% L + 5 \text{ pt})$
Resolution	1 A

Specific characteristics in PEAK mode in True-Inrush (from 10Hz to 1 kHz in AC):

- Uncertainties: add $\pm (1.5\% L + 0.5A)$ to the values in the tables above.
- PEAK capture time: 1ms min. to 1.5ms max.

4.2.6 Continuity measurement

Measurement range	0.0 Ω to 599.9 Ω
Open-circuit voltage	$\leq 3,6 \text{ V}$
Measurement current	550 μA
Uncertainties	$\pm (1\% R + 5 \text{ pt})$
Buzzer triggering threshold	Adjustable from 1 Ω to 599 Ω (40 Ω is the default)

4.2.7 Resistance measurement

Measurement range (1)	0.0 Ω to 599.9 Ω	600 Ω to 5999 Ω	6.00 k Ω to 59.99 k Ω
Specified measurement range	1 to 100% of the measurement range	0 to 100% of the measurement range	
Uncertainties	$\pm (1\% R + 5 \text{ pt})$		
Resolution	0.1 Ω	1 Ω	10 Ω
Open-circuit voltage	$\leq 3,6 \text{ V}$		
Measurement current	550 μA	100 μA	10 μA

Note (1) - Above the maximum display value, the display unit indicates "OL".
 - The "-" and "+" signs are not managed.

Specific characteristics in MAX/MIN mode:

- Uncertainties: add 1% R to the values of the table above.
- Capture time of the extrema: approximately 100ms.

4.2.8 Diode test

Measurement range	0.000V to 3.199V DC
-------------------	---------------------

Specified measurement range	1 to 100% of the measurement range
Uncertainties	$\pm (1\% R + 10 \text{ pt})$
Resolution	0.001V
Measurement current	0.55 mA
Indication: junction reversed or open-circuit	Display of "OL" when the measured voltage $>3.199\text{V}$

 **Note** : The "-" sign is disabled for the diode test function.

4.2.9 Frequency measurements

4.2.9.1 Characteristics in voltage

Measurement range (1)	5.0 Hz to 599.9 Hz	600 Hz to 5999 Hz	6.00 kHz to 19.99 kHz
Specified measurement range	1 to 100% of the measurement range	0 to 100% of the measurement range	
Uncertainties	$\pm (0.4\% R + 1 \text{ pt})$		
Resolution	0.1Hz	1Hz	10Hz

4.2.9.2 Characteristics in current

Measurement range (1)	5.0 Hz to 599,9 Hz	600 Hz to 2999 Hz
Specified measurement range	1 to 100% of the measurement range	0 to 100% of the measurement range
Uncertainties	$\pm (0.4\% R + 1 \text{ pt})$	
Resolution	0.1Hz	1Hz

Note (1) If the level of the signal is too low ($U < 3\text{V}$ or $I < 3\text{A}$) or if the frequency is less than 5Hz, the device cannot determine the frequency and displays dashes "----".

Specific characteristics in MAX/MIN mode (from 10Hz to 5kHz in voltage and from 10Hz to 1kHz in current):

- Uncertainties: add 1% R to the values of the table above.
- Capture time of the extrema: approximately 100ms.

4.2.10 Temperature measurement

Function	External temperature
----------	----------------------

Type of sensor	K thermocouple	
Measurement range	-60.0°C to +599.9°C -76.0°F to +1111.8°F	+600°C to +1200°C +1112°F to +2192°F
Specified measurement range	1 to 100% of the measurement range	0 to 100% of the measurement range
Uncertainties (1)	1% R \pm 3°C 1% R \pm 5.4°F	1% R \pm 3°C 1% R \pm 5.4°F
Resolution	0.1°C 0.1°F	1°C 1°F

Note (1) - The stated external temperature measurement accuracy does not take the accuracy of the K thermocouple into account.

Note 2 - use of the thermal time constant (0.7min/°C):
- If there is a sudden variation of the temperature of the clamp, by 10°C for example, the clamp will be at 99% (cnst= 5) of the final temperature after 0.7min/°C \times 10°C \times 5= 35 min (to which must be added the constant of the external sensor).

Specific characteristics in MAX/MIN mode:

- Uncertainties: add 1% R to the values of the table above.
- Capture time of the extrema: approximately 100ms.

4.2.11 Adapter function measurement

4.2.11.1 In DC mode

Measurement range (1)	0.0-599.9 mV	0.60-5.99 V
Specified measurement range (2)	0 to 100% of the measurement range	
Uncertainties	1% L +3pt	
Resolution	0.1 mV	10 mV
Input impedance	10 M Ω	

4.2.11.2 In AC mode

Measurement range (1)	5.0-599.9 mV	0.60-5.99 V
-----------------------	--------------	-------------

Specified measurement range (2)	1 to 100% of the measurement range	0 to 100% of the measurement range
Uncertainties	5.0 mV to 59.9 mV ± (1% L + 10 pt) 60.0 mV to 599.9 mV ± (1% L + 3 pt)	1% L + 3pt
Resolution	0.1 mV	10 mV
Input impedance	10 MΩ	

Note (1) The basic display is 6000 points. The position of the decimal point and the display of multiples (m and k) depend on the programming of the scale factor.

- In DC, the display indicates "+OL" above +5999 points and "-OL" below -5999 points. The "-" and "+" signs are managed (polarity).
- In AC, the display indicates "OL" above 5999 points.

Note (2) - the max. bandwidth is 1kHz.

Specific characteristics in MAX/MIN mode (from 10Hz to 1kHz):

- Uncertainties : add 1% R to the values of the table above.
- Time to capture of extrema : approximately 100ms.

4.3 ENVIRONMENTAL CONDITIONS

Environmental conditions	in use	in storage
Temperature	-20 C to + 55 C	-40 °C to + 70°C
Relative humidity (RH):	≤90% at 55°C	≤90% up to 70° C

4.4 CHARACTERISTICS OF CONSTRUCTION

Housing:	Rigid polycarbonate shell with moulded elastomer covering
----------	---

Jaws:	Polycarbonate Opening: 34 mm Clamping diameter: 34 mm
Screen:	LCD display unit Blue backlighting Dimension: 28x43.5 mm
Dimension:	H-222 x W-78 x D-42 mm
Weight:	340g (with the batteries)

4.5 POWER SUPPLY

Battery:	1 x 9V LF22
Mean life:	>130 hours (without backlighting)
Duration of operation before automatic switching off:	After 10 minutes without action on the switch and/or keys

4.6 COMPLIANCE WITH INTERNATIONAL STANDARDS

Electric safety:	Compliant with standards IEC-61010-1, IEC-61010-2-30, and IEC-61010-2-32: 1000V CAT-III or 600V CAT-IV.
Electromagnetic compatibility:	Compliant with standard EN-61326-1 Classification: residential environment
Mechanical strength:	Free fall: 2m (in accordance with standard IEC-68-2-32)
Level of protection of the housing:	IP40 (per standard IEC-60529)

4.7 VARIATIONS IN THE DOMAIN OF USE

Quantity of influence	Range of influence	Quantity influenced	Influence	
			Typical	MAX

Temperature	-20...+55°C	V AC V DC A T°C Hz Ω 	- 0,1%R/10°C 1%R/10°C (0,2%R+1°C)/10°C 0,1%R/10°C + 2pt	0,1%R/10°C 0,5%R/10°C + 2 pt 1,5%R/10°C + 2pt (0,3%R+2°C)/10°C 0,1%R/10°C + 3pt
Humidity	10%...90%RH	V A	0.1%R	0.1%R + 1 pt
Frequency	10Hz...1kHz 1kHz...3kHz 10Hz...400Hz 400Hz...3kHz	V A	1%R 8%R 1%R 4%R	1%R + 1 pt 9%R + 1 pt 1%R + 1 pt 5%R + 1 pt
Position of the conductor in the jaws (f≤400Hz)	Any position on the internal perimeter of the jaws	A	2%R	4%R + 1 pt
Adjacent conductor carrying a current of 150 A DC or RMS	Conductor touching the external perimeter of the jaws	A	42 dB	35 dB
Conductor enclosed by the clamp	0-500 A RMS	V	< 1 pt	1 pt
Application of a voltage on the clamp	0-1000V DC or RMS	A	< 1 pt	3% R + 1 pt
peak factor	1.4 to 3.5, limited to 900 A peak 1400V peak	A (AC) V (AC)	1%R 1%R	3% R + 1 pt

5 MAINTENANCE

The instrument has no parts that can be replaced by personnel who are not trained and approved. Any non-approved repair or other work, or replacement of a part by an "equivalent", may severely compromise safety.

5.1 CLEANING

- Disconnect everything connected to the device and set the switch to OFF.

- Use a soft cloth moistened with soapy water. Rinse with a damp cloth and dry quickly using a dry cloth or forced air.
- Dry perfectly before putting back into use.

5.2 REPLACEMENT OF THE BATTERY

The  symbol indicates that the battery is spent. When this symbol appears on the display unit, the battery must be replaced. The measurements and specifications are no longer guaranteed.

To replace the battery, proceed as follows:

1. Disconnect the measurement leads from the input terminals.
2. Set the switch to OFF.
3. Use a screwdriver to unscrew the screw securing the battery compartment cover to the back of the housing and open the cover (see [§3.1](#)).
4. Replace the battery (see [§3.1](#)).
5. Close the cover and screw it to the housing.

5.3 METROLOGICAL CHECK

Like all measuring or testing devices, the instrument must be checked regularly. This instrument should be checked at least once a year. For checks and calibrations, contact one of our accredited metrology laboratories (information and contact details available on request), at our Chauvin Arnoux subsidiary or the branch in your country.

5.4 REPAIR

For all repairs before or after expiry of warranty, please return the device to your distributor.

6 WARRANTY

Except as otherwise stipulated, our warranty is valid for three years starting from the date on which the equipment was sold. Extract from our General Conditions of Sale provided on request.

The warranty does not apply in the following cases:

- Inappropriate use of the equipment or use with incompatible equipment;

- Modifications made to the equipment without the explicit permission of the manufacturer's technical staff;
- Work done on the device by a person not approved by the manufacturer;
- Adaptation to a particular application not anticipated in the definition of the equipment or not indicated in the user's manual;
- Damage caused by shocks, falls, or floods.

7 DELIVERY CONDITION

The **F203** clamp multimeter is delivered in its packaging box with :

- 2 banana-test probe leads, one red and one black
- 1 K thermocouple with banana terminations
- 1 9V battery
- 1 carrying bag
- 1 multilingual user guide on a mini-CD
- 1 multilingual getting started guide



01 - 2015
692883A02 - Ed. 5

DEUTSCHLAND - Chauvin Arnoux GmbH
Ohmstraße 1 - 77694 Kehl / Rhein
Tel: (07851) 99 26-0 - Fax: (07851) 99 26-60

UNITED KINGDOM - Chauvin Arnoux Ltd
Unit 1 Nelson Court – Flagship Square-Shaw Cross Business Park
Dewsbury – West Yorkshire – WF12 7TH
Tel: 019244 460 494 – Fax: 01924 455 328

ITALIA - Amra SpA
Via Sant'Ambrogio, 23/25 - 20846 Macherio (MB)
Tel: 039 245 75 45 - Fax: 039 481 561

ÖSTERREICH - Chauvin Arnoux Ges.m.b.H
Slamastrasse 29/2/4 - 1230 Wien
Tel: 01 61 61 961-0 - Fax: 01 61 61 961-61

SCANDINAVIA - CA Mätssystem AB
Sjöflygvägen 35 - SE 18304 TÄBY
Tel: +46 8 50 52 68 00 - Fax: +46 8 50 52 68 10

SCHWEIZ - Chauvin Arnoux AG
Moosacherstrasse 15 - 8804 AU / ZH
Tel: 044 727 75 55 - Fax: 044 727 75 56

中国 – 上海浦江埃纳迪斯仪表有限公司
上海市虹口区祥德路381号3号楼3楼
Tel: +86 21 65 21 51 96 - Fax: +86 21 65 21 61 07

ESPAÑA - Chauvin Arnoux Ibérica S.A.
C/ Roger de Flor, 293 - 1a Planta - 08025 Barcelona
Tel: 90 220 22 26 - Fax: 93 459 14 43

MIDDLE EAST - Chauvin Arnoux Middle East
P.O. BOX 60-154 - 1241 2020 JAL EL DIB (Beirut) – LEBANON
Tel: (01) 89 04 25 - Fax: (01) 89 04 24

USA - Chauvin Arnoux Inc - d.b.a AEMC Instruments
200 Foxborough Blvd. - Foxborough - MA 02035
Tel: (508) 698-2115 - Fax: (508) 698-2118

<http://www.chauvin-arnoux.com>

190, rue Championnet - 75876 PARIS Cedex 18 - FRANCE

Tél. : +33 1 44 85 44 85 - Fax : +33 1 46 27 73 89 - info@chauvin-arnoux.fr

Export : Tél. : +33 1 44 85 44 86 - Fax : +33 1 46 27 95 59 - export@chauvin-arnoux.fr